

Твердосплавные вставки

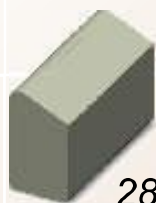

2878



2879



5620

NL 300

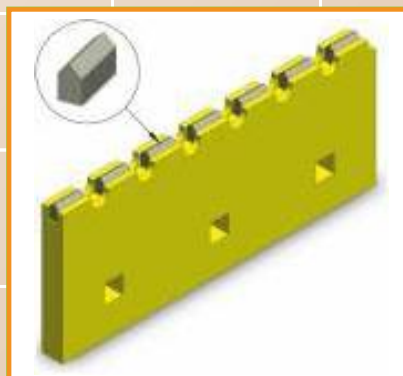
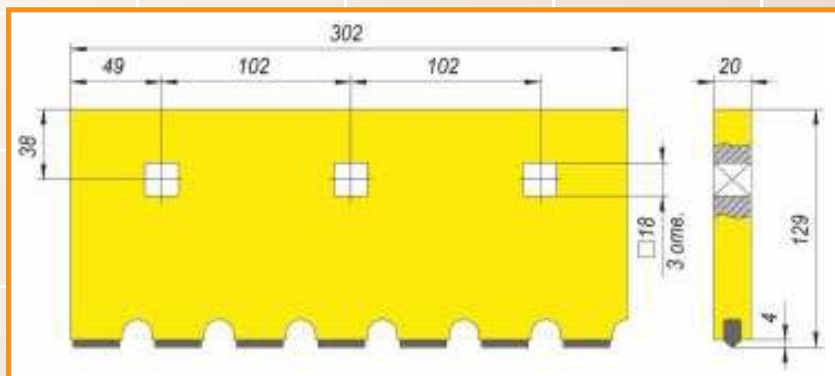

NL 792

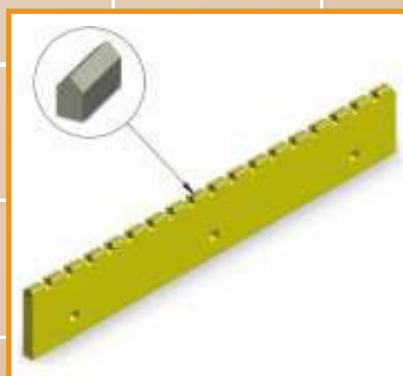
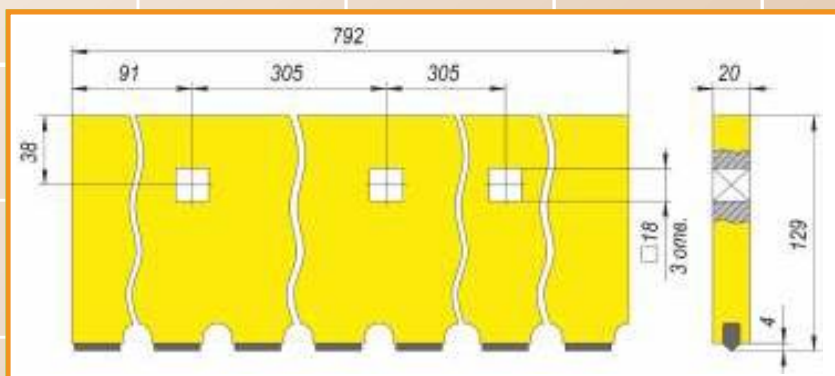

NL 915

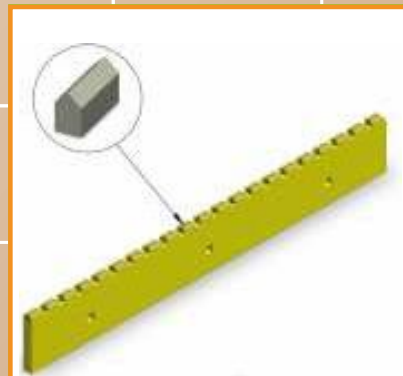
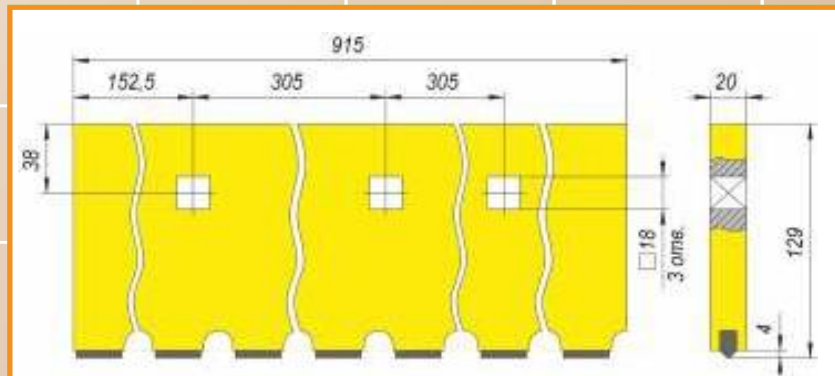

*Все размеры приведены в мм.





NL 1220

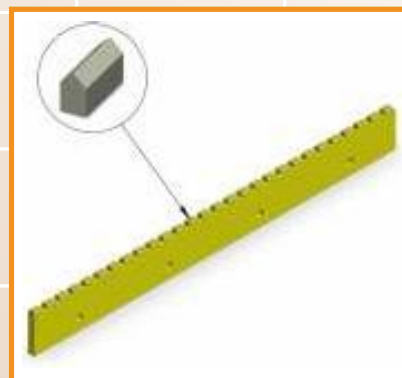
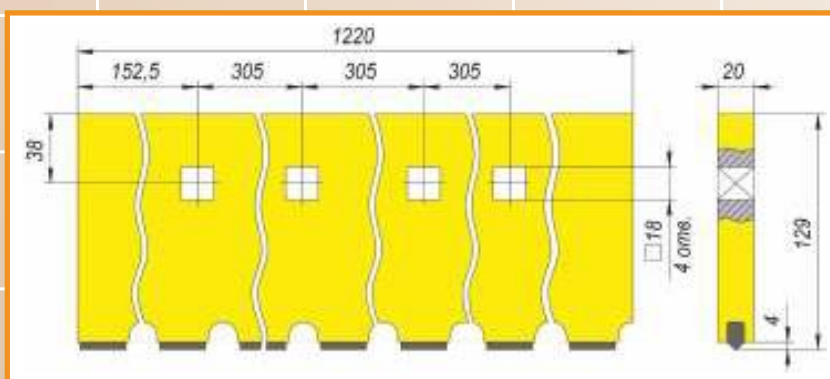

NT 6.20-915

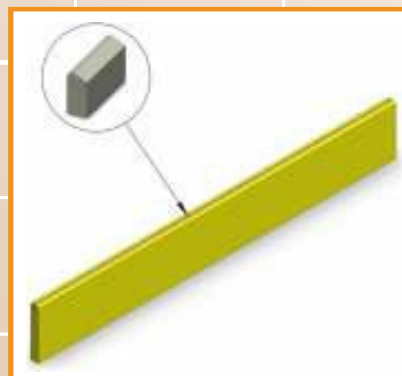
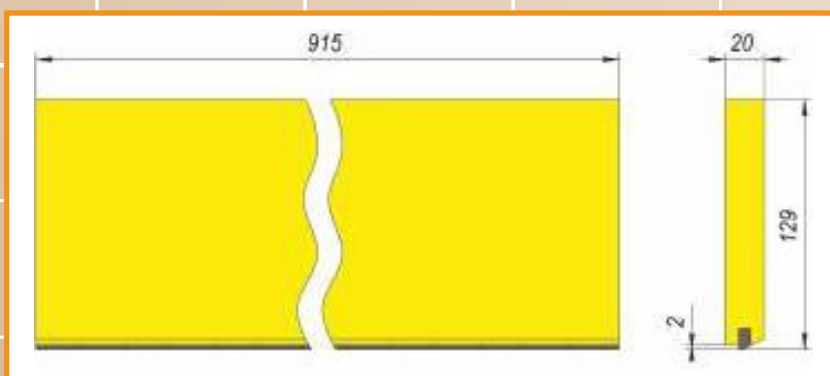

NT 6.20-1200

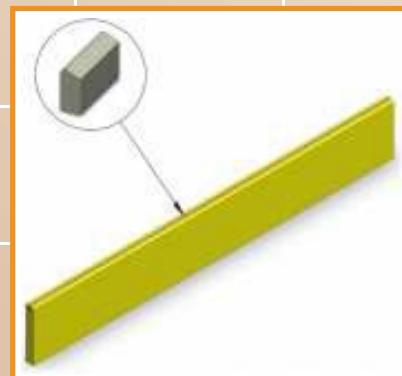
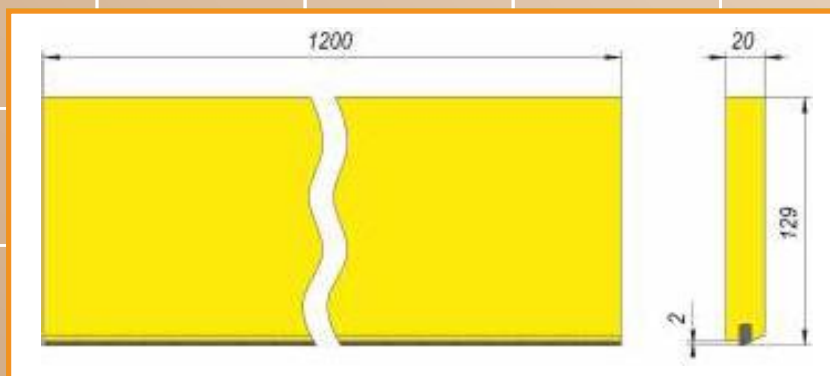

*Все размеры приведены в мм.



NT 300

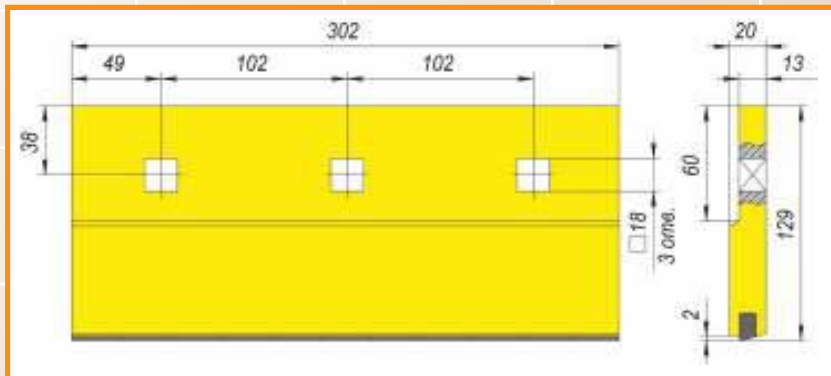

NT 610

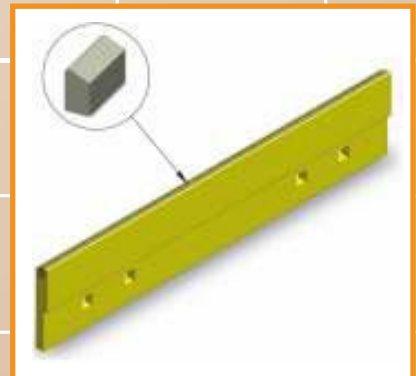
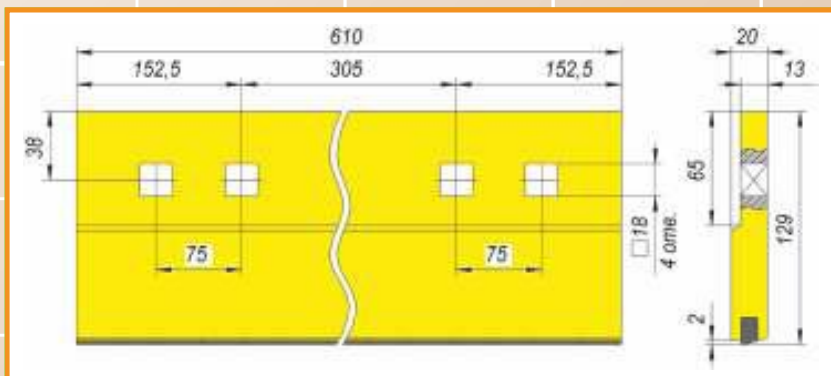

NT 792

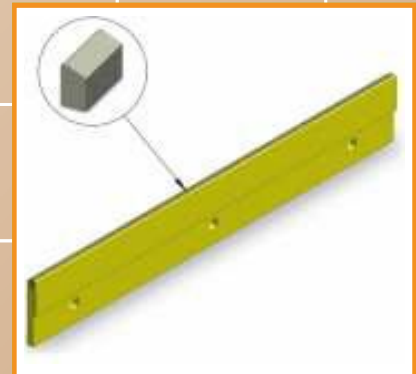
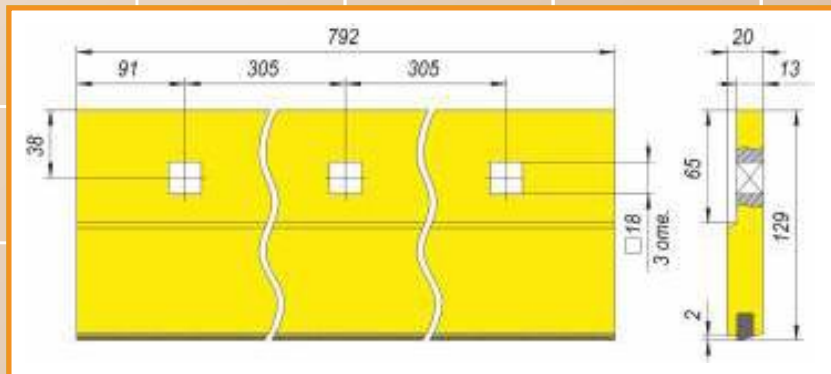

*Все размеры приведены в мм.





NT 900

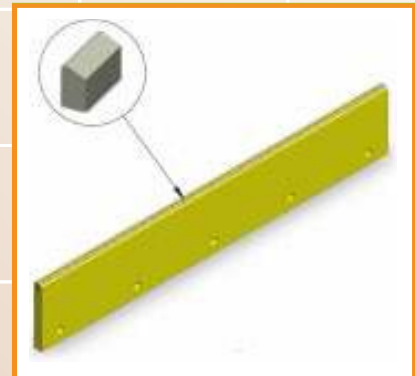
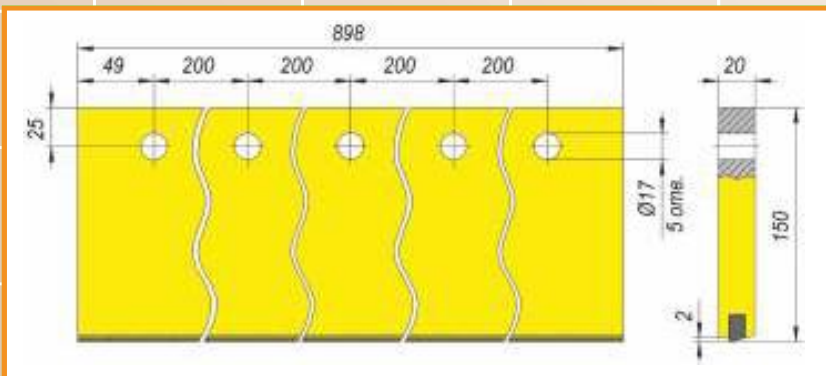

NT 915

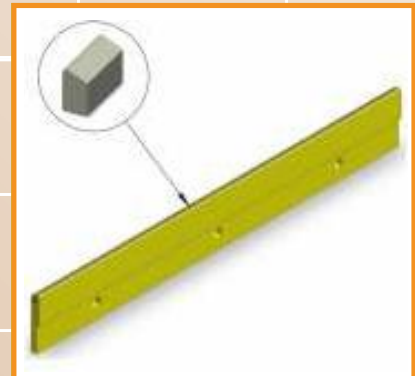
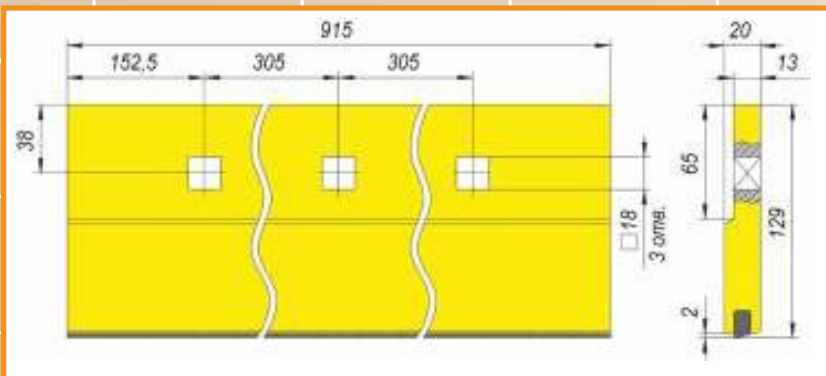

NT 980

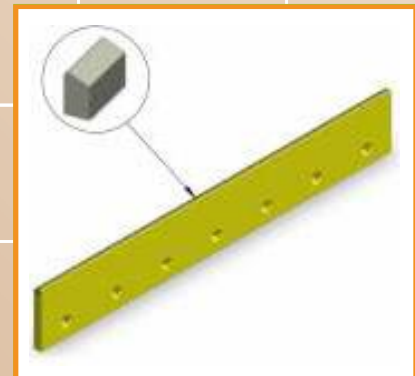
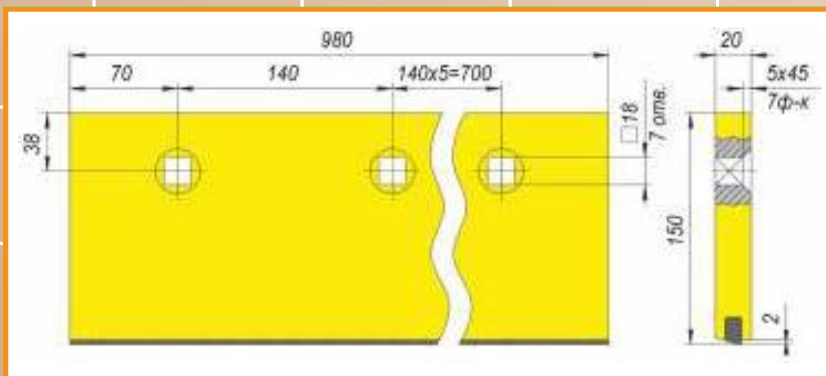

*Все размеры приведены в мм.



NT 1200.310

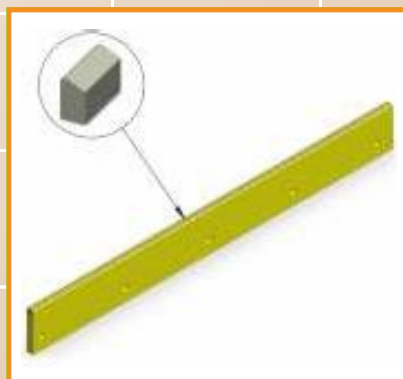
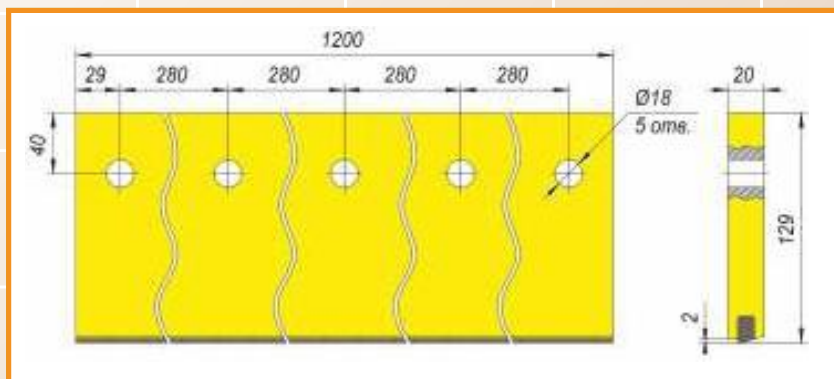

NT 1200.311

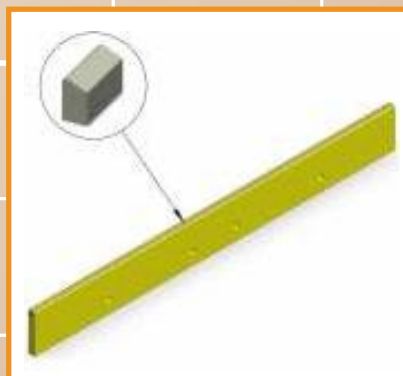
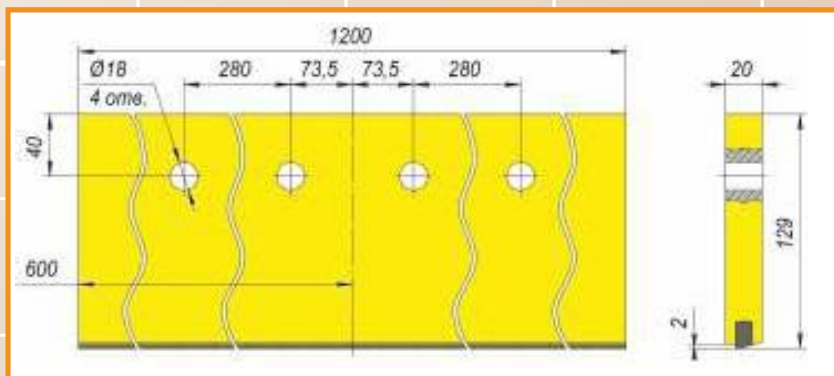

NT 1200.500

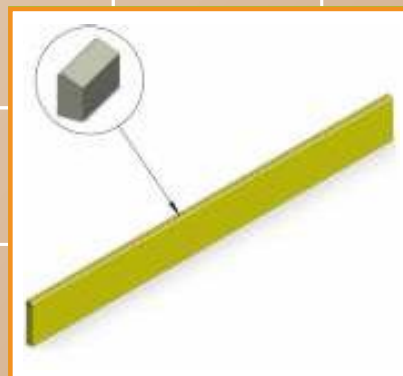
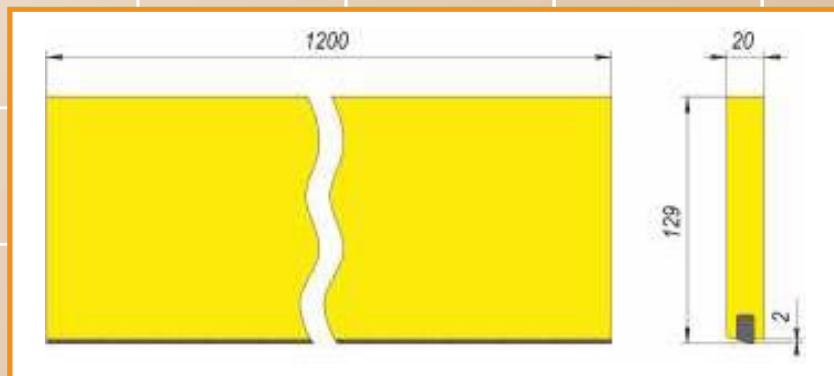

*Все размеры приведены в мм.



NT 1220.000

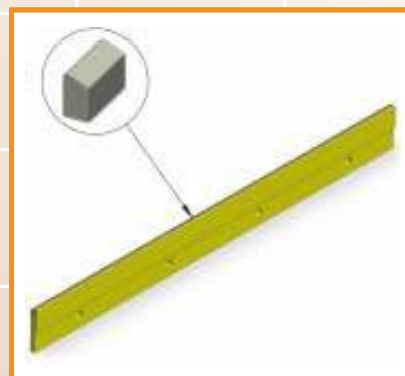
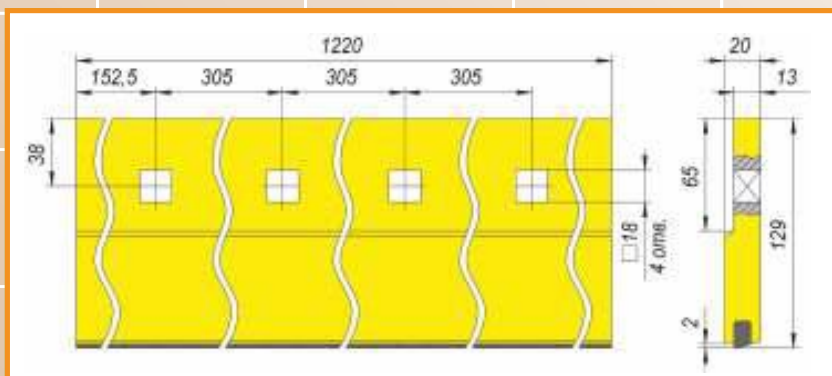

NT 1220.500

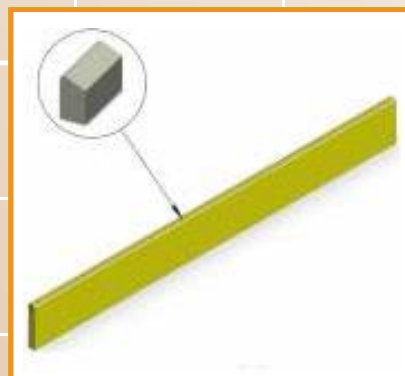
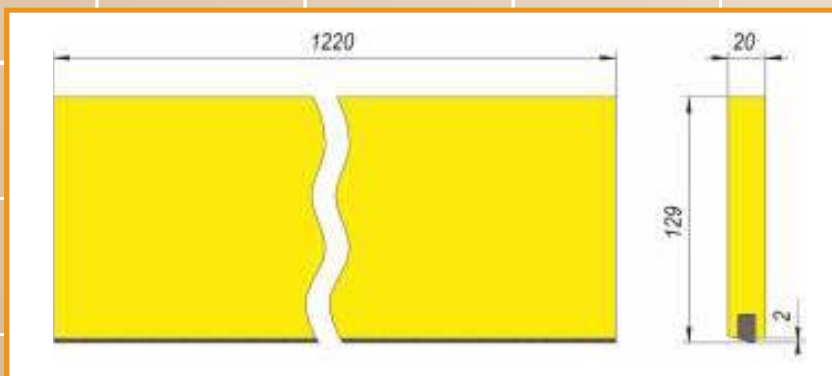

NT 1260

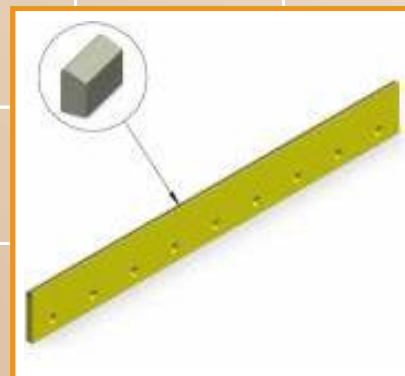
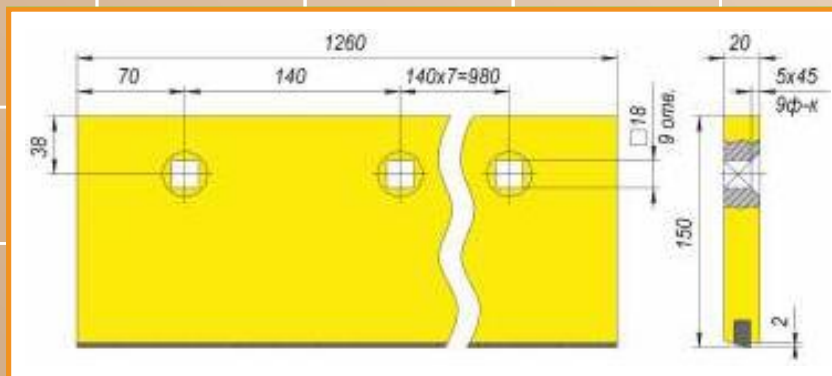

*Все размеры приведены в мм.



NT 1365

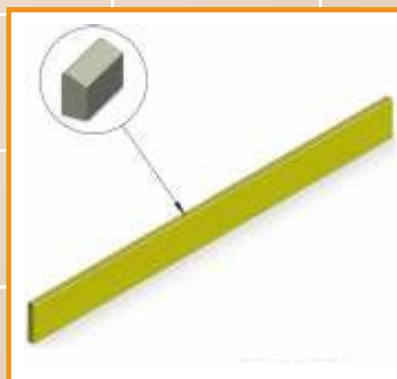
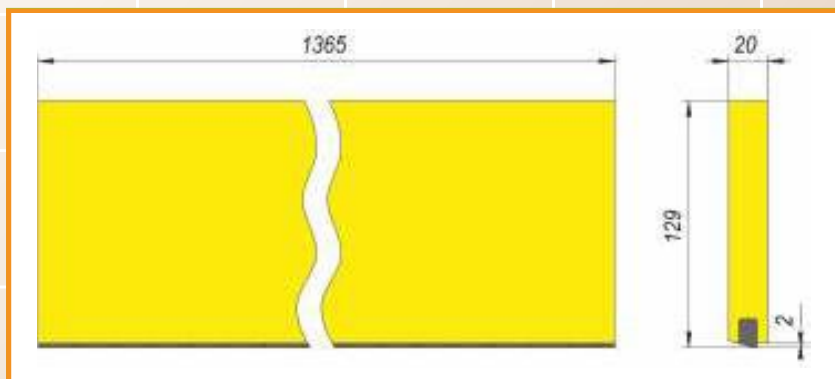

NTK 912

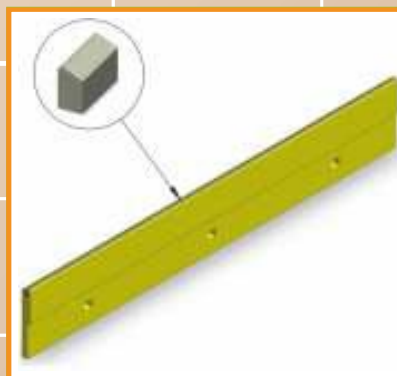
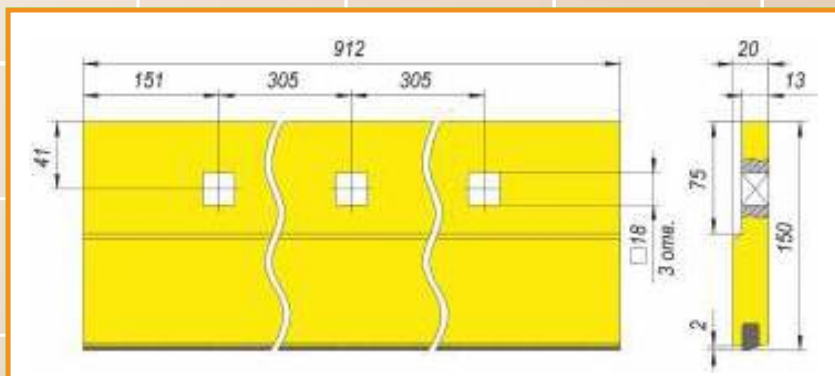

NTK 998

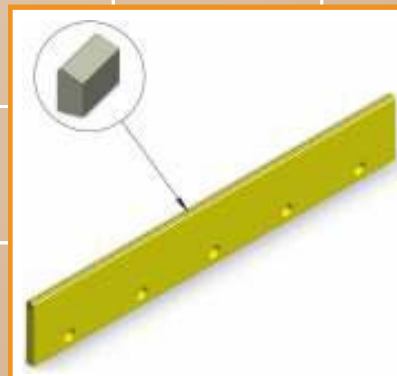
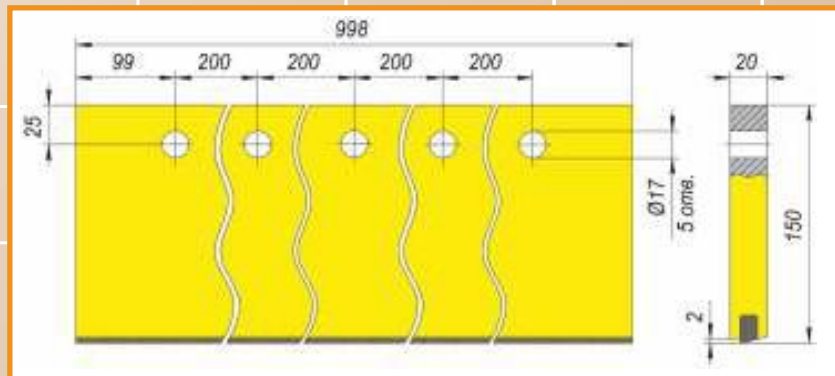

*Все размеры приведены в мм.

Резцовые грейдерные ножи

NR 415

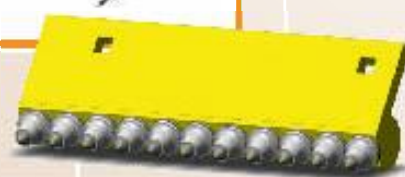
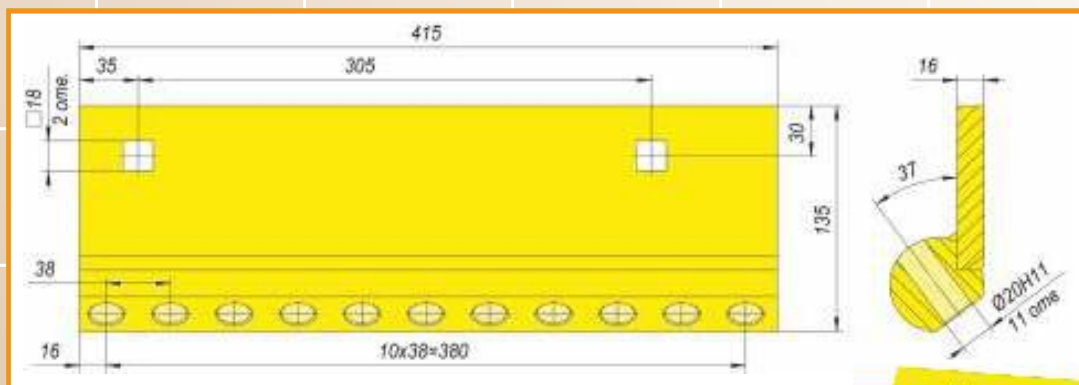

NR 529

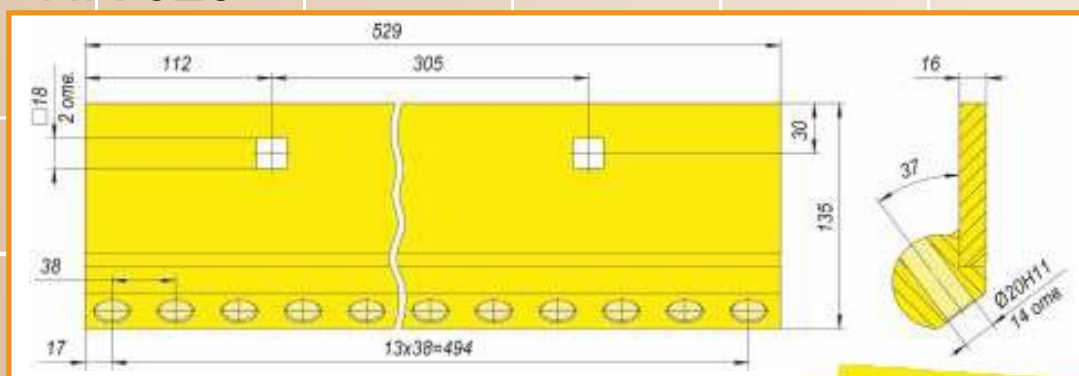

NR 912

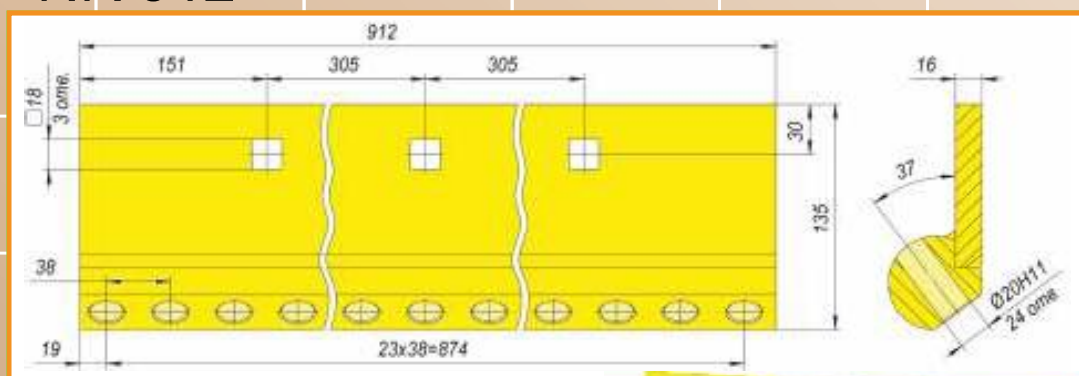

*Все размеры приведены в мм.