

M2-BF23

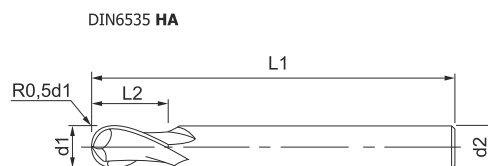

- ◆ Двухзубая сферическая фреза ($R=0,5d_1$)
- ◆ Центральные режущие кромки (сфера)
- ◆ Для общего применения



DIN6535 HB

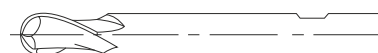

Средняя серия

d1h10	L1	L2	d2h6	ЦИЛИНДРИЧЕСКИЙ (HA)	WELDON (HB)
3,0	57	7	6,0	M2-BF23-030/07C06M	M2-BF23-030/07W06M
4,0	57	8	6,0	M2-BF23-040/08C06M	M2-BF23-040/08W06M
5,0	57	10	6,0	M2-BF23-050/10C06M	M2-BF23-050/10W06M
6,0	57	10	6,0	M2-BF23-060/10C06M	M2-BF23-060/10W06M
7,0	63	16	8,0	M2-BF23-070/16C08M	M2-BF23-070/16W08M
8,0	63	16	8,0	M2-BF23-080/16C08M	M2-BF23-080/16W08M
9,0	72	19	9,0	M2-BF23-090/19C09M	M2-BF23-090/19W09M
10,0	72	19	10,0	M2-BF23-100/19C10M	M2-BF23-100/19W10M
12,0	83	22	12,0	M2-BF23-120/22C12M	M2-BF23-120/22W12M
14,0	83	22	14,0	M2-BF23-140/22C14M	M2-BF23-140/22W14M
16,0	92	26	16,0	M2-BF23-160/26C16M	M2-BF23-160/26W16M
18,0	92	26	18,0	M2-BF23-180/26C18M	M2-BF23-180/26W18M
20,0	104	32	20,0	M2-BF23-200/32C20M	M2-BF23-200/32W20M

Длинная серия

d1h10	L1	L2	d2h6	ЦИЛИНДРИЧЕСКИЙ (HA)	WELDON (HB)
4,0	75	8	6,0	M2-BF23-040/08C06L	M2-BF23-040/08W06L
6,0	100	10	6,0	M2-BF23-060/10C06L	M2-BF23-060/10W06L
8,0	100	16	8,0	M2-BF23-080/16C08L	M2-BF23-080/16W08L
10,0	100	19	10,0	M2-BF23-100/19C10L	M2-BF23-100/19W10L
12,0	100	22	12,0	M2-BF23-120/22C12L	M2-BF23-120/22W12L
14,0	100	22	14,0	M2-BF23-140/22C14L	M2-BF23-140/22W14L
16,0	150	26	16,0	M2-BF23-160/26C16L	M2-BF23-160/26W16L
18,0	150	26	18,0	M2-BF23-180/26C18L	M2-BF23-180/26W18L
20,0	150	32	20,0	M2-BF23-200/32C20L	M2-BF23-200/32W20L

M2-BF23U



- ◆ Двухзубая сферическая фреза ($R=0,5d_1$) с занижением диаметра шейки
- ◆ Центральные режущие кромки (сфера)
- ◆ Для общего применения

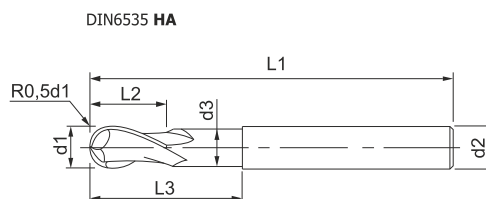

DIN6535 HB

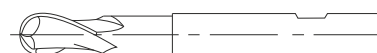

Длинная серия

d1h10	L1	L2	d2h6	d3	L3	ЦИЛИНДРИЧЕСКИЙ (HA)	WELDON (HB)
3,0	75	12	6,0	2,8	22	M2-BF23U-030/12C06L	M2-BF23U-030/12W06L
4,0	75	16	6,0	3,8	26	M2-BF23U-040/16C06L	M2-BF23U-040/16W06L
5,0	75	20	6,0	4,8	37	M2-BF23U-050/20C06L	M2-BF23U-050/20W06L
6,0	75	20	6,0	5,8	37	M2-BF23U-060/20C06L	M2-BF23U-060/20W06L
8,0	75	20	8,0	7,8	37	M2-BF23U-080/20C08L	M2-BF23U-080/20W08L
10,0	100	20	10,0	9,8	40	M2-BF23U-100/20C10L	M2-BF23U-100/20W10L
12,0	100	20	12,0	11,7	40	M2-BF23U-120/20C12L	M2-BF23U-120/20W12L
14,0	100	20	14,0	13,7	40	M2-BF23U-140/20C14L	M2-BF23U-140/20W14L
16,0	120	30	16,0	15,7	70	M2-BF23U-160/30C16L	M2-BF23U-160/30W16L
18,0	120	30	18,0	17,7	70	M2-BF23U-180/30C18L	M2-BF23U-180/30W18L
20,0	132	30	20,0	19,7	80	M2-BF23U-200/30C20L	M2-BF23U-200/30W20L

Сверхдлинная серия

d1h10	L1	L2	d2h6	d3	L3	ЦИЛИНДРИЧЕСКИЙ (HA)	WELDON (HB)
5,0	100	20	6,0	4,8	40	M2-BF23U-050/20C06X	M2-BF23U-050/20W06X
6,0	100	20	6,0	5,8	40	M2-BF23U-060/20C06X	M2-BF23U-060/20W06X
8,0	100	20	8,0	7,8	40	M2-BF23U-080/20C08X	M2-BF23U-080/20W08X
10,0	150	20	10,0	9,8	60	M2-BF23U-100/20C10X	M2-BF23U-100/20W10X
12,0	150	20	12,0	11,7	60	M2-BF23U-120/20C12X	M2-BF23U-120/20W12X
14,0	150	20	14,0	13,7	60	M2-BF23U-140/20C14X	M2-BF23U-140/20W14X
16,0	150	30	16,0	15,7	70	M2-BF23U-160/30C16X	M2-BF23U-160/30W16X
18,0	150	30	18,0	17,7	70	M2-BF23U-180/30C18X	M2-BF23U-180/30W18X
20,0	150	30	20,0	19,7	80	M2-BF23U-200/30C20X	M2-BF23U-200/30W20X

M2-BS11U



- ◆ Двухзубая сферическая фреза ($R=0,5d_1$) с занижением диаметра шейки
- ◆ Центральные режущие кромки
- ◆ Для обработки закалённых сталей до 68 HRC

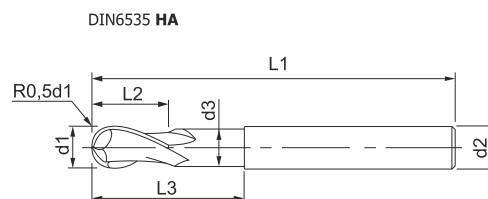

DIN6535 HB

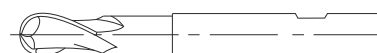

Средняя серия

d1h9	L1	L2	d2h6	d3	L3	ЦИЛИНДРИЧЕСКИЙ (HA)	WELDON (HB)
3,0	50	3	3,0	2,9	15	M2-BS11U-030/03C03M	—
4,0	50	4	4,0	3,9	15	M2-BS11U-040/04C04M	—
5,0	55	5	5,0	4,8	18	M2-BS11U-050/05C05M	—
6,0	62	6	6,0	5,8	20	M2-BS11U-060/06C06M	M2-BS11U-060/06W06M
8,0	75	8	8,0	7,8	27	M2-BS11U-080/08C08M	M2-BS11U-080/08W08M
10,0	80	10	10,0	9,8	30	M2-BS11U-100/10C10M	M2-BS11U-100/10W10M
12,0	85	12	12,0	11,7	35	M2-BS11U-120/12C12M	M2-BS11U-120/12W12M
14,0	90	14	14,0	13,7	38	M2-BS11U-140/14C14M	M2-BS11U-140/14W14M
16,0	93	16	16,0	15,7	38	M2-BS11U-160/16C16M	M2-BS11U-160/16W16M

Длинная серия

d1h9	L1	L2	d2h6	d3	L3	ЦИЛИНДРИЧЕСКИЙ (HA)	WELDON (HB)
3,0	60	6	3,0	2,9	20	M2-BS11U-030/06C03L	—
4,0	60	8	4,0	3,9	20	M2-BS11U-040/08C04L	—
5,0	75	10	5,0	4,8	23	M2-BS11U-050/10C05L	—
6,0	80	12	6,0	5,8	25	M2-BS11U-060/12C06L	M2-BS11U-060/12W06L
8,0	100	14	8,0	7,8	35	M2-BS11U-080/14C08L	M2-BS11U-080/14W08L
10,0	110	18	10,0	9,8	40	M2-BS11U-100/18C10L	M2-BS11U-100/18W10L
12,0	110	22	12,0	11,7	45	M2-BS11U-120/22C12L	M2-BS11U-120/22W12L
14,0	115	26	14,0	13,7	48	M2-BS11U-140/26C14L	M2-BS11U-140/26W14L
16,0	125	28	16,0	15,7	50	M2-BS11U-160/28C16L	M2-BS11U-160/28W16L

M2-BS12U



- ◆ Двухзубая сферическая фреза ($R=0,5d_1$) с занижением диаметра шейки
- ◆ Центральные режущие кромки (сфера)
- ◆ Для профильной обработки холодноштампованных сталей с HRC 54-60

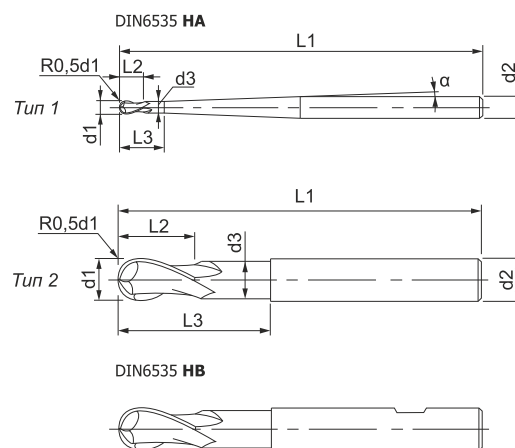
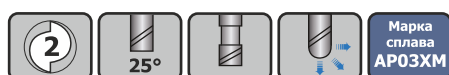
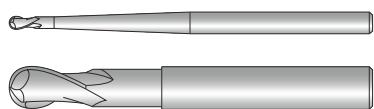

Короткая серия

d1h9	L1	L2	d2h6	d3	L3	α°	ЦИЛИНДРИЧЕСКИЙ (HA)	WELDON (HB)
3,0	51	4	6,0	2,9	9	20	M2-BS12U-030/04C06S	M2-BS12U-030/04W06S
4,0	58	6	6,0	3,9	11	15	M2-BS12U-040/06C06S	M2-BS12U-040/06W06S
6,0	60	8	6,0	5,9	16	-	M2-BS12U-060/08C06S	M2-BS12U-060/08W06S
8,0	70	10	8,0	7,8	25	-	M2-BS12U-080/10C08S	M2-BS12U-080/10W08S
10,0	75	12	10,0	9,8	30	-	M2-BS12U-100/12C10S	M2-BS12U-100/12W10S
12,0	90	14	12,0	11,8	45	-	M2-BS12U-120/14C12S	M2-BS12U-120/14W12S

Средняя серия

d1h9	L1	L2	d2h6	d3	L3	α°	ЦИЛИНДРИЧЕСКИЙ (HA)	WELDON (HB)
3,0	54	5	6,0	2,9	12	20	M2-BS12U-030/05C06M	M2-BS12U-030/05W06M
4,0	58	6	6,0	3,9	16	15	M2-BS12U-040/06C06M	M2-BS12U-040/06W06M
6,0	70	8	6,0	5,9	25	-	M2-BS12U-060/08C06M	M2-BS12U-060/08W06M
8,0	80	10	8,0	7,8	40	-	M2-BS12U-080/10C08M	M2-BS12U-080/10W08M
10,0	100	12	10,0	9,8	60	-	M2-BS12U-100/12C10M	M2-BS12U-100/12W10M
12,0	135	14	12,0	11,8	90	-	M2-BS12U-120/14C12M	M2-BS12U-120/14W12M

Длинная серия

d1h9	L1	L2	d2h6	d3	L3	α°	ЦИЛИНДРИЧЕСКИЙ (HA)	WELDON (HB)
3,0	58	5	6,0	2,9	18	20	M2-BS12U-030/05C06L	M2-BS12U-030/05W06L
4,0	67	6	6,0	3,9	24	15	M2-BS12U-040/06C06L	M2-BS12U-040/06W06L
6,0	70	8	6,0	5,9	35	-	M2-BS12U-060/08C06L	M2-BS12U-060/08W06L
8,0	100	10	8,0	7,8	60	-	M2-BS12U-080/10C08L	M2-BS12U-080/10W08L
10,0	120	12	10,0	9,8	80	-	M2-BS12U-100/12C10L	M2-BS12U-100/12W10L

Сверхдлинная серия

d1h9	L1	L2	d2h6	d3	L3	α°	ЦИЛИНДРИЧЕСКИЙ (НА)	WELDON (НВ)
3,0	67	5	6,0	2,9	24	20	M2-BS12U-030/05C06X	M2-BS12U-030/05W06X
4,0	72	6	6,0	3,9	36	15	M2-BS12U-040/06C06X	M2-BS12U-040/06W06X
6,0	80	8	6,0	5,9	45	-	M2-BS12U-060/08C06X	M2-BS12U-060/08W06X



Возможно изготовление инструмента по размерам заказчика и с другим видом износостойкого покрытия

M2-BF13U



- ◆ Двухзубая сферическая фреза ($R=0,5d_1$) с занижением диаметра шейки
- ◆ Центральные режущие кромки (сфера)
- ◆ Для профильной обработки горячештамповых сталей с HRC 48-54

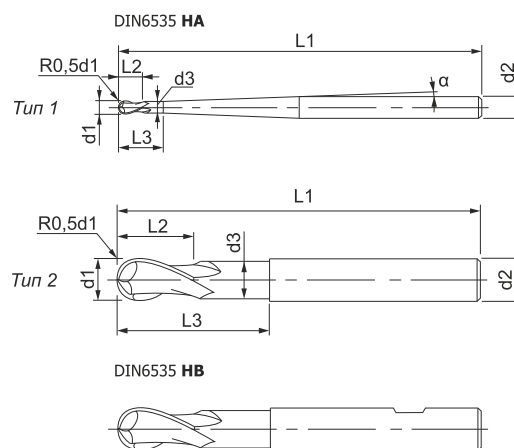
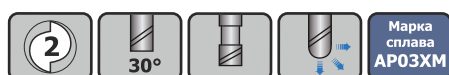
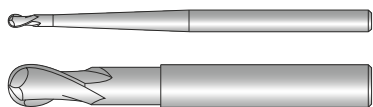

Короткая серия

d1h9	L1	L2	d2h6	d3	L3	α°	ЦИЛИНДРИЧЕСКИЙ (HA)	WELDON (HB)
3,0	51	4	6,0	2,9	9	20	M2-BF13U-030/04C06S	M2-BF13U-030/04W06S
4,0	58	6	6,0	3,9	11	15	M2-BF13U-040/06C06S	M2-BF13U-040/06W06S
6,0	60	8	6,0	5,9	16	-	M2-BF13U-060/08C06S	M2-BF13U-060/08W06S
8,0	70	10	8,0	7,8	25	-	M2-BF13U-080/10C08S	M2-BF13U-080/10W08S
10,0	75	12	10,0	9,8	30	-	M2-BF13U-100/12C10S	M2-BF13U-100/12W10S
12,0	90	14	12,0	11,8	45	-	M2-BF13U-120/14C12S	M2-BF13U-120/14W12S

Средняя серия

d1h9	L1	L2	d2h6	d3	L3	α°	ЦИЛИНДРИЧЕСКИЙ (HA)	WELDON (HB)
3,0	54	5	6,0	2,9	12	20	M2-BF13U-030/05C06M	M2-BF13U-030/05W06M
4,0	58	6	6,0	3,9	16	15	M2-BF13U-040/06C06M	M2-BF13U-040/06W06M
6,0	70	8	6,0	5,9	25	-	M2-BF13U-060/08C06M	M2-BF13U-060/08W06M
8,0	80	10	8,0	7,8	40	-	M2-BF13U-080/10C08M	M2-BF13U-080/10W08M
10,0	100	12	10,0	9,8	60	-	M2-BF13U-100/12C10M	M2-BF13U-100/12W10M
12,0	135	14	12,0	11,8	90	-	M2-BF13U-120/14C12M	M2-BF13U-120/14W12M

Длинная серия

d1h9	L1	L2	d2h6	d3	L3	α°	ЦИЛИНДРИЧЕСКИЙ (HA)	WELDON (HB)
3,0	58	5	6,0	2,9	18	20	M2-BF13U-030/05C06L	M2-BF13U-030/05W06L
4,0	67	6	6,0	3,9	24	15	M2-BF13U-040/06C06L	M2-BF13U-040/06W06L
6,0	70	8	6,0	5,9	35	-	M2-BF13U-060/08C06L	M2-BF13U-060/08W06L
8,0	100	10	8,0	7,8	60	-	M2-BF13U-080/10C08L	M2-BF13U-080/10W08L
10,0	120	12	10,0	9,8	80	-	M2-BF13U-100/12C10L	M2-BF13U-100/12W10L

Сверхдлинная серия

d1h9	L1	L2	d2h6	d3	L3	α°	ЦИЛИНДРИЧЕСКИЙ (НА)	WELDON (НВ)
3,0	67	5	6,0	2,9	24	20	M2-BF13U-030/05C06X	M2-BF13U-030/05W06X
4,0	72	6	6,0	3,9	36	15	M2-BF13U-040/06C06X	M2-BF13U-040/06W06X
6,0	80	8	6,0	5,9	45	-	M2-BF13U-060/08C06X	M2-BF13U-060/08W06X



Возможно изготовление инструмента по размерам заказчика и с другим видом износостойкого покрытия

M2-BA54



- ◆ Двухзубая сферическая фреза ($R=0,5d_1$)
- ◆ Центральные режущие кромки
- ◆ Для профильной обработки цветных металлов и пластика (полированные канавки)

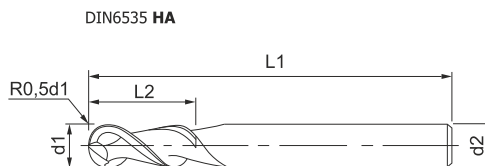

DIN6535 HB

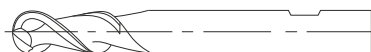

Короткая серия

d1h10	L1	L2	d2h6	ЦИЛИНДРИЧЕСКИЙ (HA)	WELDON (HB)
3,0	50	6	3,0	M2-BA54-030/06C03S	—
4,0	54	7	4,0	M2-BA54-040/07C04S	—
5,0	54	8	5,0	M2-BA54-050/08C05S	—
6,0	54	10	6,0	M2-BA54-060/10C06S	M2-BA54-060/10W06S
8,0	59	12	8,0	M2-BA54-080/12C08S	M2-BA54-080/12W08S
10,0	67	13	10,0	M2-BA54-100/13C10S	M2-BA54-100/13W10S
12,0	73	16	12,0	M2-BA54-120/16C12S	M2-BA54-120/16W12S
14,0	75	18	14,0	M2-BA54-140/18C14S	M2-BA54-140/18W14S
16,0	83	20	16,0	M2-BA54-160/20C16S	M2-BA54-160/20W16S
18,0	88	22	18,0	M2-BA54-180/22C18S	M2-BA54-180/22W18S
20,0	93	24	20,0	M2-BA54-200/24C20S	M2-BA54-200/24W20S

Длинная серия

d1h10	L1	L2	d2h6	ЦИЛИНДРИЧЕСКИЙ (HA)	WELDON (HB)
3,0	65	9	3,0	M2-BA54-030/09C03L	—
4,0	70	11	4,0	M2-BA54-040/11C04L	—
5,0	70	14	5,0	M2-BA54-050/14C05L	—
6,0	75	16	6,0	M2-BA54-060/16C06L	M2-BA54-060/16C06L
8,0	80	20	8,0	M2-BA54-080/20C08L	M2-BA54-080/20C08L
10,0	80	22	10,0	M2-BA54-100/22C10L	M2-BA54-100/22C10L
12,0	90	24	12,0	M2-BA54-120/24C12L	M2-BA54-120/24C12L
14,0	90	26	14,0	M2-BA54-140/26C14L	M2-BA54-140/26C14L
16,0	130	28	16,0	M2-BA54-160/28C16L	M2-BA54-160/28C16L
18,0	130	34	18,0	M2-BA54-180/34C18L	M2-BA54-180/34C18L
20,0	130	38	20,0	M2-BA54-200/38C20L	M2-BA54-200/38C20L

M2-BA64



- ◆ Двухзубая сферическая фреза ($R=0,5d_1$) со стружко-разделительными насечками на ленточке
- ◆ Центральные режущие кромки (сфера)
- ◆ Для полустойчивой профильной обработки цветных металлов и пластика (полированные канавки)

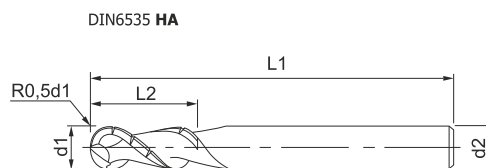

DIN6535 HA

DIN6535 HB

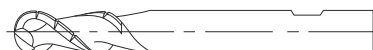

Средняя серия

d1h10	L1	L2	d2h6	ЦИЛИНДРИЧЕСКИЙ (HA)	WELDON (HB)
3,0	60	8	3,0	M2-BA64-030/08C03M	—
4,0	64	10	4,0	M2-BA64-040/10C04M	—
5,0	64	12	5,0	M2-BA64-050/12C05M	—
6,0	64	14	6,0	M2-BA64-060/14C06M	M2-BA64-060/14W06M
8,0	70	18	8,0	M2-BA64-080/18C08M	M2-BA64-080/18W08M
10,0	75	20	10,0	M2-BA64-100/20C10M	M2-BA64-100/20W10M
12,0	80	22	12,0	M2-BA64-120/22C12M	M2-BA64-120/22W12M
14,0	85	24	14,0	M2-BA64-140/24C14M	M2-BA64-140/24W14M
16,0	95	26	16,0	M2-BA64-160/26C16M	M2-BA64-160/26W16M
18,0	100	32	18,0	M2-BA64-180/32C18M	M2-BA64-180/32W18M
20,0	110	36	20,0	M2-BA64-200/36C20M	M2-BA64-200/36W20M

Сверхдлинная серия

d1h10	L1	L2	d2h6	ЦИЛИНДРИЧЕСКИЙ (HA)	WELDON (HB)
3,0	75	10	3,0	M2-BA64-030/10C03X	—
4,0	75	13	4,0	M2-BA64-040/13C04X	—
5,0	75	15	5,0	M2-BA64-050/15C05X	—
6,0	100	16	6,0	M2-BA64-060/16C06X	M2-BA64-060/16W06X
8,0	100	22	8,0	M2-BA64-080/22C08X	M2-BA64-080/22W08X
10,0	100	25	10,0	M2-BA64-100/25C10X	M2-BA64-100/25W10X
12,0	100	26	12,0	M2-BA64-120/26C12X	M2-BA64-120/26W12X
14,0	100	28	14,0	M2-BA64-140/28C14X	M2-BA64-140/28W14X
16,0	150	30	16,0	M2-BA64-160/30C16X	M2-BA64-160/30W16X
18,0	150	36	18,0	M2-BA64-180/36C18X	M2-BA64-180/36W18X
20,0	150	40	20,0	M2-BA64-200/40C20X	M2-BA64-200/40W20X

M4-BH48



- ◆ Четырёхзубая сферическая фреза (R=0,5d1) усиленная
- ◆ Антивибрационная геометрия, HPC
- ◆ Центральные режущие кромки (сферы)
- ◆ Для общего применения

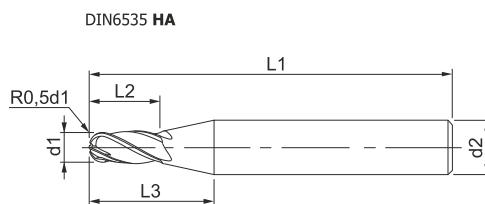

DIN6535 HB

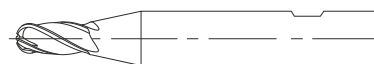

Короткая серия

d1h9	L1	L2	d2h6	L3	ЦИЛИНДРИЧЕСКИЙ (HA)	WELDON (HB)
3,0	50	4	6,0	10	M2-BH48-030/04C06S	M2-BH48-030/04W06S
4,0	50	6	6,0	12	M2-BH48-040/06C06S	M2-BH48-040/06W06S
5,0	50	8	6,0	14	M2-BH48-050/08C06S	M2-BH48-050/08W06S
6,0	50	9	6,0	-	M2-BH48-060/09C06S	M2-BH48-060/09W06S

Средняя серия

d1h9	L1	L2	d2h6	L3	ЦИЛИНДРИЧЕСКИЙ (HA)	WELDON (HB)
3,0	56	6	6,0	16	M2-BH48-030/06C06M	M2-BH48-030/06W06M
4,0	56	8	6,0	18	M2-BH48-040/08C06M	M2-BH48-040/08W06M
5,0	56	10	6,0	20	M2-BH48-050/10C06M	M2-BH48-050/10W06M
6,0	56	12	6,0	-	M2-BH48-060/12C06M	M2-BH48-060/12W06M

Длинная серия

d1h9	L1	L2	d2h6	L3	ЦИЛИНДРИЧЕСКИЙ (HA)	WELDON (HB)
3,0	67	9	6,0	19	M2-BH48-030/09C06L	M2-BH48-030/09W06L
4,0	67	12	6,0	22	M2-BH48-040/12C06L	M2-BH48-040/12W06L
5,0	67	15	6,0	25	M2-BH48-050/15C06L	M2-BH48-050/15W06L
6,0	67	18	6,0	-	M2-BH48-060/18C06L	M2-BH48-060/18W06L

Сверхдлинная серия

d1h9	L1	L2	d2h6	L3	ЦИЛИНДРИЧЕСКИЙ (HA)	WELDON (HB)
3,0	80	12	6,0	22	M2-BH48-030/12C06X	M2-BH48-030/12W06X
4,0	80	16	6,0	26	M2-BH48-040/16C06X	M2-BH48-040/16W06X
5,0	80	20	6,0	30	M2-BH48-050/20C06X	M2-BH48-050/20W06X
6,0	80	24	6,0	-	M2-BH48-060/24C06X	M2-BH48-060/24W06X

M4-BH48U



- ◆ Четырёхзубая сферическая фреза ($R=0,5d1$)
- ◆ Антивибрационная геометрия, HPC
- ◆ Центральные режущие кромки (сфера)
- ◆ Для общего применения

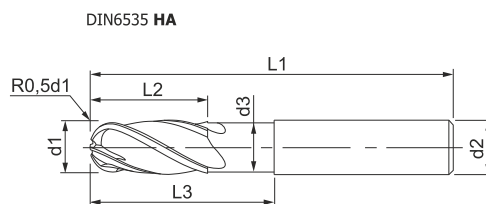

DIN6535 HA

DIN6535 HB



Короткая серия

d1h10	L1	L2	d2h6	d3	L3	ЦИЛИНДРИЧЕСКИЙ (HA)	WELDON (HB)
3,0	54	6	6,0	2,8	16	M4-BH48U-030/06C06S	M4-BH48U-030/06W06S
4,0	54	8	6,0	3,8	18	M4-BH48U-040/08C06S	M4-BH48U-040/08W06S
5,0	54	9	6,0	4,8	18	M4-BH48U-050/09C06S	M4-BH48U-050/09W06S
6,0	54	10	6,0	5,5	18	M4-BH48U-060/10C06S	M4-BH48U-060/10W06S
7,0	58	12	8,0	6,5	21	M4-BH48U-070/12C08S	M4-BH48U-070/12W08S
8,0	58	12	8,0	7,5	21	M4-BH48U-080/12C08S	M4-BH48U-080/12W08S
9,0	66	14	10,0	8,5	24	M4-BH48U-090/14C10S	M4-BH48U-090/14W10S
10,0	66	14	10,0	9,5	24	M4-BH48U-100/14C10S	M4-BH48U-100/14W10S
11,0	73	16	12,0	10,5	28	M4-BH48U-110/16C12S	M4-BH48U-110/16W12S
12,0	73	16	12,0	11,0	28	M4-BH48U-120/16C12S	M4-BH48U-120/16W12S
13,0	73	16	14,0	12,0	28	M4-BH48U-130/16C14S	M4-BH48U-130/16W14S
14,0	75	18	14,0	13,0	30	M4-BH48U-140/18C14S	M4-BH48U-140/18W14S
16,0	82	22	16,0	15,0	32	M4-BH48U-160/22C16S	M4-BH48U-160/22W16S
18,0	90	24	18,0	17,0	50	M4-BH48U-180/24C18S	M4-BH48U-180/24W18S
20,0	92	26	20,0	29,0	50	M4-BH48U-200/26C20S	M4-BH48U-200/26W20S
25,0	102	32	25,0	24,0	55	M4-BH48U-250/32C25S	M4-BH48U-250/32W25S



Возможно изготовление инструмента по размерам заказчика и с другим видом износостойкого покрытия

Средняя серия

d1h10	L1	L2	d2h6	d3	L3	ЦИЛИНДРИЧЕСКИЙ (НА)	WELDON (HB)
3,0	57	8	6,0	2,8	21	M4-BH48U-030/08C06M	M4-BH48U-030/08W06M
4,0	57	11	6,0	3,8	21	M4-BH48U-040/11C06M	M4-BH48U-040/11W06M
5,0	57	13	6,0	4,8	21	M4-BH48U-050/13C06M	M4-BH48U-050/13W06M
6,0	57	13	6,0	5,5	21	M4-BH48U-060/13C06M	M4-BH48U-060/13W06M
7,0	63	19	8,0	6,5	27	M4-BH48U-070/19C08M	M4-BH48U-070/19W08M
8,0	63	19	8,0	7,5	27	M4-BH48U-080/19C08M	M4-BH48U-080/19W08M
9,0	72	22	10,0	8,5	32	M4-BH48U-090/22C10M	M4-BH48U-090/22W10M
10,0	72	22	10,0	9,5	32	M4-BH48U-100/22C10M	M4-BH48U-100/22W10M
12,0	83	26	12,0	11,0	38	M4-BH48U-120/26C12M	M4-BH48U-120/26W12M
13,0	83	26	14,0	12,0	42	M4-BH48U-130/26C14M	M4-BH48U-130/26W14M
14,0	83	26	14,0	13,0	42	M4-BH48U-140/26C14M	M4-BH48U-140/26W14M
16,0	92	32	16,0	15,0	44	M4-BH48U-160/32C16M	M4-BH48U-160/32W16M
18,0	94	32	18,0	17,0	50	M4-BH48U-180/32C18M	M4-BH48U-180/32W18M
20,0	104	38	20,0	29,0	54	M4-BH48U-200/38C20M	M4-BH48U-200/38W20M
25,0	108	38	25,0	24,0	60	M4-BH48U-250/38C25M	M4-BH48U-250/38W25M

Длинная серия

d1h10	L1	L2	d2h6	d3	L3	ЦИЛИНДРИЧЕСКИЙ (НА)	WELDON (HB)
3,0	80	8	6,0	2,8	22	M4-BH48U-030/08C06L	M4-BH48U-030/08W06L
4,0	80	11	6,0	3,8	22	M4-BH48U-040/11C06L	M4-BH48U-040/11W06L
5,0	80	21	6,0	4,8	31	M4-BH48U-050/21C06L	M4-BH48U-050/21W06L
6,0	80	22	6,0	5,5	31	M4-BH48U-060/22C06L	M4-BH48U-060/22W06L
7,0	80	28	8,0	6,5	40	M4-BH48U-070/28C08L	M4-BH48U-070/28W08L
8,0	80	28	8,0	7,5	40	M4-BH48U-080/28C08L	M4-BH48U-080/28W08L
9,0	100	33	10,0	8,5	43	M4-BH48U-090/33C10L	M4-BH48U-090/33W10L
10,0	100	33	10,0	9,5	43	M4-BH48U-100/33C10L	M4-BH48U-100/33W10L
12,0	100	42	12,0	11,0	52	M4-BH48U-120/42C12L	M4-BH48U-120/42W12L
14,0	100	43	14,0	13,0	55	M4-BH48U-140/43C14L	M4-BH48U-140/43W14L
16,0	121	45	16,0	15,0	62	M4-BH48U-160/45C16L	M4-BH48U-160/45W16L
18,0	121	45	18,0	17,0	62	M4-BH48U-180/45C18L	M4-BH48U-180/45W18L
20,0	128	50	20,0	29,0	74	M4-BH48U-200/50C20L	M4-BH48U-200/50W20L
25,0	132	50	25,0	24,0	74	M4-BH48U-250/50C25L	M4-BH48U-250/50W25L



Возможно изготовление инструмента по размерам заказчика и с другим видом износостойкого покрытия

Сверхдлинная серия

d1h10	L1	L2	d2h6	d3	L3	ЦИЛИНДРИЧЕСКИЙ (НА)	WELDON (НВ)
10,0	100	40	10,0	9,2	50	M4-BH48U-100/40C10X	M4-BH48U-100/40W10X
12,0	150	45	12,0	11,0	55	M4-BH48U-120/45C12X	M4-BH48U-120/45W12X
14,0	150	45	14,0	13,0	60	M4-BH48U-140/45C14X	M4-BH48U-140/45W14X
15,0	150	53	16,0	14,0	99	M4-BH48U-150/53C16X	M4-BH48U-150/53W16X
16,0	150	65	16,0	15,0	99	M4-BH48U-160/65C16X	M4-BH48U-160/65W16X
18,0	150	65	18,0	17,0	99	M4-BH48U-180/65C18X	M4-BH48U-180/65W18X
20,0	151	68	20,0	29,0	99	M4-BH48U-200/68C20X	M4-BH48U-200/68W20X
25,0	157	75	25,0	24,0	99	M4-BH48U-250/75C25X	M4-BH48U-250/75W25X



Возможно изготовление инструмента по размерам заказчика и с другим видом износостойкого покрытия

M4-BF83



- ◆ Четырёхзубая сферическая фреза ($R=0,5d_1$)
- ◆ Центральные режущие кромки (сфера)
- ◆ Для чистовой обработки стали, чугуна и цветных металлов

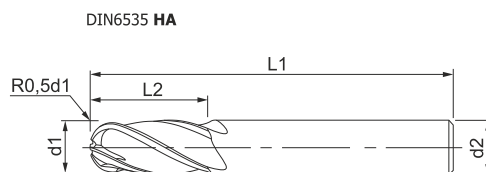

DIN6535 HB

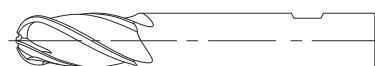

Средняя серия

d1h10	L1	L2	d2h6	ЦИЛИНДРИЧЕСКИЙ (HA)	WELDON (HB)
3,0	57	8	6,0	M4-BF83-030/08C06M	M4-BF83-030/08W06M
4,0	57	11	6,0	M4-BF83-040/11C06M	M4-BF83-040/11W06M
5,0	57	13	6,0	M4-BF83-050/13C06M	M4-BF83-050/13W06M
6,0	57	13	6,0	M4-BF83-060/13C06M	M4-BF83-060/13W06M
8,0	63	19	8,0	M4-BF83-080/19C08M	M4-BF83-080/19W08M
10,0	72	22	10,0	M4-BF83-100/22C10M	M4-BF83-100/22W10M
12,0	83	26	12,0	M4-BF83-120/26C12M	M4-BF83-120/26W12M
14,0	83	26	14,0	M4-BF83-140/26C14M	M4-BF83-140/26W14M
16,0	92	32	16,0	M4-BF83-160/32C16M	M4-BF83-160/32W16M
18,0	92	32	18,0	M4-BF83-180/32C18M	M4-BF83-180/32W18M
20,0	104	38	20,0	M4-BF83-200/38C20M	M4-BF83-200/38W20M

Длинная серия

d1h10	L1	L2	d2h6	ЦИЛИНДРИЧЕСКИЙ (HA)	WELDON (HB)
3,0	57	20	6,0	M4-BF83-030/20C06L	M4-BF83-030/20W06L
4,0	57	20	6,0	M4-BF83-040/20C06L	M4-BF83-040/20W06L
5,0	75	30	6,0	M4-BF83-050/30C06L	M4-BF83-050/30W06L
6,0	75	30	6,0	M4-BF83-060/30C06L	M4-BF83-060/30W06L
8,0	75	30	8,0	M4-BF83-080/30C08L	M4-BF83-080/30W08L
10,0	75	30	10,0	M4-BF83-100/30C10L	M4-BF83-100/30W10L
12,0	100	45	12,0	M4-BF83-120/45C12L	M4-BF83-120/45W12L
14,0	100	45	14,0	M4-BF83-140/45C14L	M4-BF83-140/45W14L
16,0	100	45	16,0	M4-BF83-160/45C16L	M4-BF83-160/45W16L
18,0	100	45	18,0	M4-BF83-180/45C18L	M4-BF83-180/45W18L
20,0	100	45	20,0	M4-BF83-200/45C20L	M4-BF83-200/45W20L

Сверхдлинная серия

d1h10	L1	L2	d2h6	ЦИЛИНДРИЧЕСКИЙ (НА)	WELDON (НВ)
6,0	100	40	6,0	M4-BF83-060/40C06X	M4-BF83-060/40W06X
8,0	100	40	8,0	M4-BF83-080/40C08X	M4-BF83-080/40W08X
10,0	100	40	10,0	M4-BF83-100/40C10X	M4-BF83-100/40W10X
12,0	150	45	12,0	M4-BF83-120/45C12X	M4-BF83-120/45W12X
12,0	150	65	12,0	M4-BF83-120/65C12X	M4-BF83-120/65W12X
14,0	150	65	14,0	M4-BF83-140/65C14X	M4-BF83-140/65W14X
16,0	150	65	16,0	M4-BF83-160/65C16X	M4-BF83-160/65W16X
16,0	150	90	16,0	M4-BF83-160/90C16X	M4-BF83-160/90W16X
18,0	150	65	18,0	M4-BF83-180/65C18X	M4-BF83-180/65W18X
20,0	150	65	20,0	M4-BF83-200/65C20X	M4-BF83-200/65W20X
20,0	150	90	20,0	M4-BF83-200/90C20X	M4-BF83-200/90W20X



Возможно изготовление инструмента по размерам заказчика и с другим видом износостойкого покрытия

M4-BF84U



- ◆ Четырёхзубая сферическая фреза ($R=0,5d_1$) с занижением диаметра шейки
- ◆ Центральные режущие кромки (сфера)
- ◆ Для полустойкой обработки стали, чугуна и цветных металлов

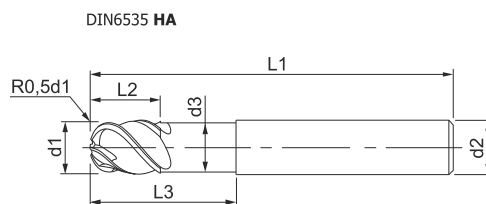

DIN6535 HB

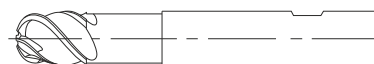

Короткая серия

d1h10	L1	L2	d2h6	d3	L3	ЦИЛИНДРИЧЕСКИЙ (HA)	WELDON (HB)
6,0	54	10	6,0	5,8	20	M4-BF84U-060/10C06S	M4-BF84U-060/10W06S
8,0	58	12	8,0	7,8	25	M4-BF84U-080/12C08S	M4-BF84U-080/12W08S
10,0	66	14	10,0	9,7	27	M4-BF84U-100/14C10S	M4-BF84U-100/14W10S
12,0	73	16	12,0	11,7	35	M4-BF84U-120/16C12S	M4-BF84U-120/16W12S
14,0	75	18	14,0	13,7	37	M4-BF84U-140/18C14S	M4-BF84U-140/18W14S
16,0	82	22	16,0	15,6	40	M4-BF84U-160/22C16S	M4-BF84U-160/22W16S
18,0	86	24	18,0	17,6	42	M4-BF84U-180/24C18S	M4-BF84U-180/24W18S
20,0	92	26	20,0	19,6	45	M4-BF84U-200/26C20S	M4-BF84U-200/26W20S

Средняя серия

d1h10	L1	L2	d2h6	d3	L3	ЦИЛИНДРИЧЕСКИЙ (HA)	WELDON (HB)
6,0	57	10	6,0	5,8	25	M4-BF84U-060/10C06M	M4-BF84U-060/10W06M
8,0	63	12	8,0	7,8	27	M4-BF84U-080/12C08M	M4-BF84U-080/12W08M
10,0	72	14	10,0	9,7	32	M4-BF84U-100/14C10M	M4-BF84U-100/14W10M
12,0	83	16	12,0	11,7	38	M4-BF84U-120/16C12M	M4-BF84U-120/16W12M
14,0	87	18	14,0	13,7	40	M4-BF84U-140/18C14M	M4-BF84U-140/18W14M
16,0	92	22	16,0	15,6	44	M4-BF84U-160/22C16M	M4-BF84U-160/22W16M
18,0	98	24	18,0	17,6	46	M4-BF84U-180/24C18M	M4-BF84U-180/24W18M
20,0	104	26	20,0	19,6	50	M4-BF84U-200/26C20M	M4-BF84U-200/26W20M



Возможно изготовление инструмента по размерам заказчика и с другим видом износостойкого покрытия

Длинная серия

d1h10	L1	L2	d2h6	d3	L3	ЦИЛИНДРИЧЕСКИЙ (НА)	WELDON (НВ)
6,0	100	10	6,0	5,8	40	M4-BF84U-060/10C06L	M4-BF84U-060/10W06L
8,0	100	12	8,0	7,8	40	M4-BF84U-080/12C08L	M4-BF84U-080/12W08L
10,0	100	14	10,0	9,7	40	M4-BF84U-100/14C10L	M4-BF84U-100/14W10L
12,0	100	16	12,0	11,7	40	M4-BF84U-120/16C12L	M4-BF84U-120/16W12L
14,0	100	18	14,0	13,7	40	M4-BF84U-140/18C14L	M4-BF84U-140/18W14L
16,0	150	22	16,0	15,6	70	M4-BF84U-160/22C16L	M4-BF84U-160/22W16L
18,0	150	24	18,0	17,6	70	M4-BF84U-180/24C18L	M4-BF84U-180/24W18L
20,0	150	26	20,0	19,6	70	M4-BF84U-200/26C20L	M4-BF84U-200/26W20L



Возможно изготовление инструмента по размерам заказчика и с другим видом износостойкого покрытия